

TLC-EC23

Patchwork Pouch

Sometimes all you want to make is one quilt block, but what to do with it? The Patchwork Pouch is a great way to use that orphaned quilt block to make a project that is useful and cute. If you prefer, you can always create a new 8½" quilt block for the occasion or you can make a simple patchwork with 2½" squares.

Fabric for Pouch Exterior

Unfinished 8 ½" quilt block OR (16) 2½" squares
2 (4½" x 8½") squares of coordinating quilting cotton
2 (9" x 9") pre-washed flannel or very thin batting
1 (1" x 3") coordinating quilting cotton

Lining for Pouch Lining:

2 (8¼" x 8½") square of quilting cotton

Coordinating thread

80/12 Universal needle

Rotary cutter

Self-healing cutting mat

Snips

Sharp pins

¼" piecing foot

Double sided basting tape

12" zipper

Share your project! @crinkledreams @teresacoates

Add the hashtag: #patchworkpouch

This pattern (including all designs, illustrations, text and all other aspects) is for personal use only. No part of this pattern may be reproduced, transmitted, or shared.

©2024 Crinkle Dreams Patchwork Pouch pattern

www.crinkledreams.com • teresa@crinkledreams.com



the Patchwork Pouch



Beginner-friendly zipper pouch that's perfect for single quilt blocks or a new patchwork design.

Create Boxed Bottom

Mark $1\frac{1}{4}$ " squares at both bottom corners of Outer Pouch and Pouch Lining.

Cut on marked lines.

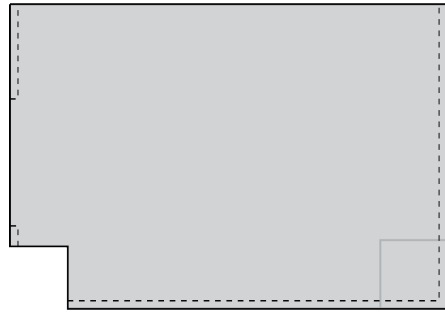

Twist cut edges to nest the bottom seam and side seam together. Pin and sew twice to secure. Repeat on remaining three corners.

Finish Your Pouch

Turn right side out through the turning gap. Press seams from right side. To close the turning gap hand sew or stitch with a narrow zigzag.

Fill your pouch and put it to use!

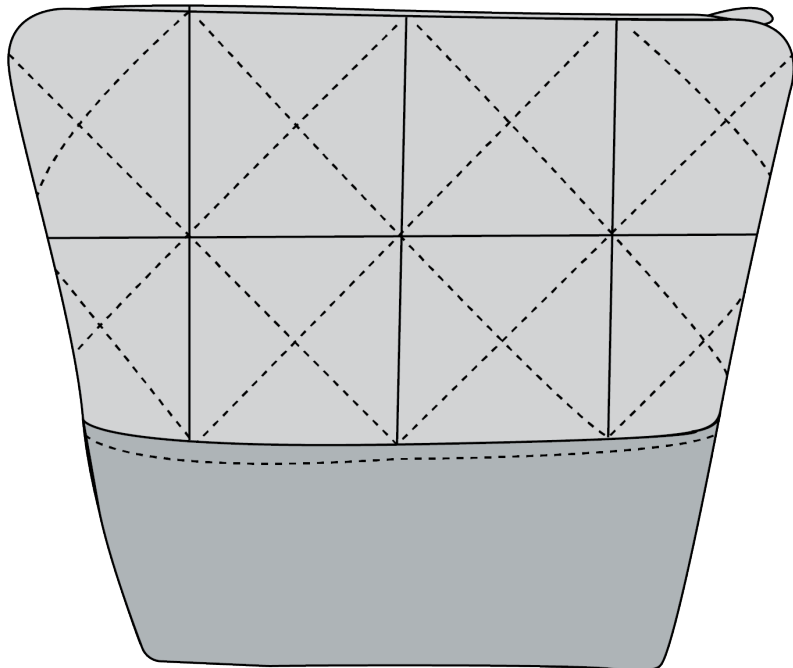

Press seam up, with seam allowance against the solid rectangle. Top stitch $1/8$ " from seam on solid (lower) rectangle. Quilt as desired.

Trim flannel/batting even with raw edge to create two approximately $8\frac{1}{4}$ " x $8\frac{1}{2}$ " pouch sides.

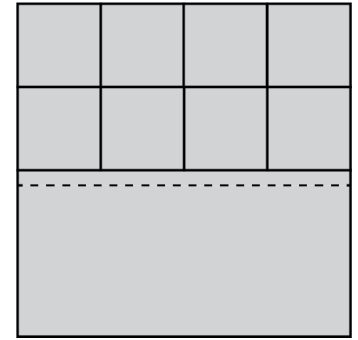

Prepare Zipper

Prepare zipper by cutting off the metal stop and remainder of zipper.

Fingerpress 1 " x 3 " rectangle in half, right sides together, and wrap over the cut end of zipper. Sew in place, onto the zipper, with $1/4$ " seam allowance.

Fingerpress seam so right sides are out and your new zipper tab extends past the zipper. Topstitch, if desired.

Set aside.

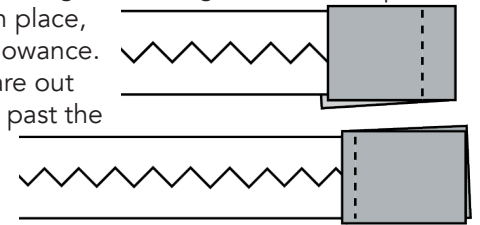

Zipper Placement

On one pouch exterior, mark both sides of fabric $3/4$ " in from left edge.

On other pouch exterior, mark both sides of fabric $3/4$ " in from right edge.

Make the same marks on both lining pieces.

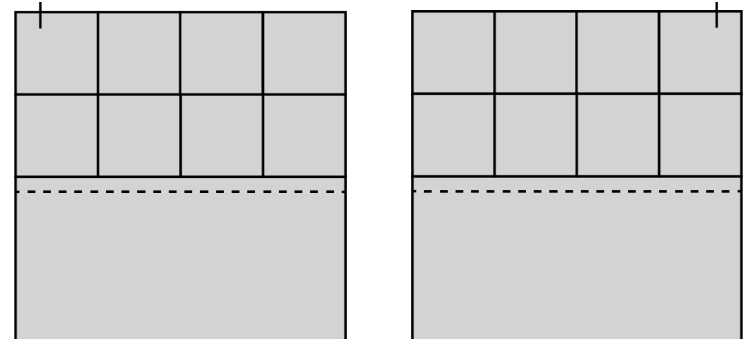

Starting at the mark made in the previous step, press basting tape along top edge of each Pouch Exterior.

Remove backing from the basting tape on one Pouch Exterior.

Line up the end of the zipper tab with the right edge, then align edge of zipper tape with top raw edge. Press into place.

NOTE: Zipper will be loose on the remaining $\frac{3}{4}$ " of top edge of Pouch Exterior.

On both Pouch Linings, adhere basting tape to right sides, along top edge, ending at the $\frac{3}{4}$ " mark as before.

Remove paper and press onto zipper tape, matching the mark on both Lining and Exterior, so remaining $\frac{3}{4}$ " of fabrics and zipper are loose.

Sew zipper with a $\frac{1}{4}$ " seam allowance, starting at the zipper tab. Stitch to the $\frac{3}{4}$ " mark, then with the needle down, pull the zipper tape to the side and into the seam allowance.

Lower presser foot again and sew over the zipper teeth. Sew remaining $\frac{3}{4}$ " and backstitch to secure.

Repeat on other Pouch Exterior, matching the zipper tab, top edge and the $\frac{3}{4}$ " mark, then adding Lining and sew together.

NOTE: The zipper ends where it turns into the seam; that end should match on both sides when zipper is closed.

Press seams away from zipper on both Exteriors and Linings.

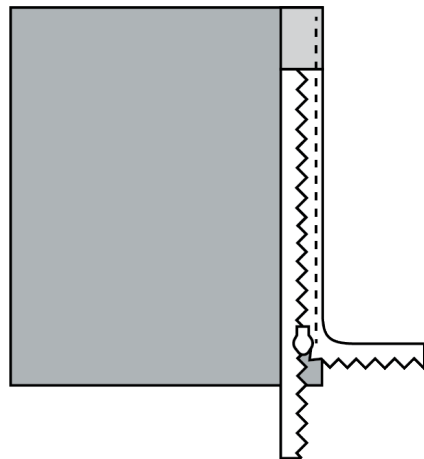
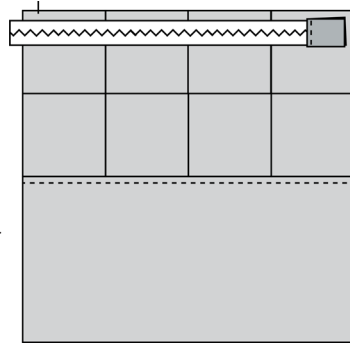

Topstitch Around Zipper

Set your stitch length to 3.0 or 3.5mm. Topstitch, starting at the $\frac{3}{4}$ " mark (end of zipper teeth), backstitch or lockstitch, then sew down the zipper edge. This stitching should run about $\frac{1}{8}$ " away from seam on Exterior fabric.

Pivot at other end of zipper, sew across the zipper tab, then back up the other side of zipper, ending parallel to where you started. Backstitch or lockstitch to secure.

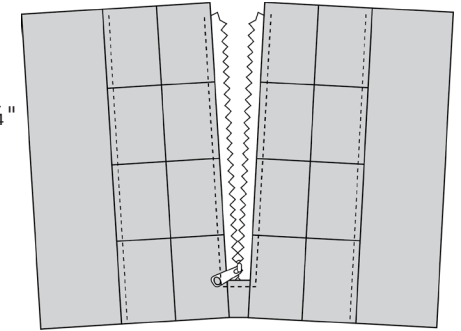

Trim extra zipper length.

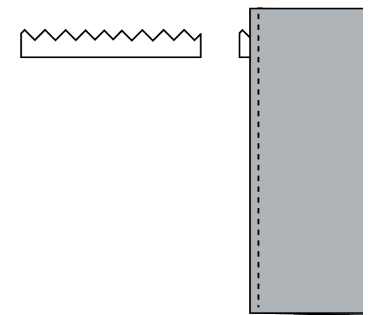

Sew Pouch Together

Mark a 3" turning gap on one side edge of Lining with a fabric-safe felt pen.

With a $\frac{1}{4}$ " seam allowance, sew around all four edges, leaving the turning gap open. At each end of turning gap, sew from seam end to raw edge of fabric to create an L-shape.

